



Noitom Hi5 VR Glove

User Guidelines

Ver. 1.4

Version Control

Version Number	Version Date	Version Reason
1.0	2017.4	Initial version
1.1	2017.09.12	1. RF performance revised; 2. Mounting optical tracking device revised; 3. Wearing glove revised; 4. Calibration motions and steps revised.
1.2	2017.11.22	1. RF performance for multiple user revised; 2. Vibration meaning changed; 3. Battery life extended.
1.3	2018.2.1	1. Add FCC statement
1.4	2018.4.13	1. The function of short press Glove button changed.

Contents

1. Introduction	1
2. Hardware Parts	2
2.1 Components	2
2.2 Interaction Interfaces	3
2.3 Features.....	4
2.4 Radio Frequency (RF).....	4
2.5 Usages.....	5
2.5.1 Basic Operation Steps	5
2.5.2 Pairing Gloves.....	6
2.5.3 Demagnetization	7
3. Mechanical Parts	9
3.1 Mounting Optical Tracking Devices	9
3.2 Wearing Gloves	12
4. SDK	14
5. Calibration Instructions	15
5.1 Notice.....	15
5.2 Calibration Steps	15

NOITOM®	Hi5 VR Glove	Developer Guidelines
	NOITOM corporation	Dec.2017 V1.2

1. Introduction

This document describes the development guidelines for content developers. It contains information on how to use the Noitom Hi5 VR Glove to enable motion capture tracking of the user's hands and fingers.

Notice:

1. Noitom Hi5 is provided as a pair. You may use them with both hands or with just one hand and one Glove.
2. It's needed to use Noitom Hi5 together with optical tracking devices in order to gain the absolute position of your hands and forearms in a tracked area and do calibration correctly.
3. Noitom Hi5 Glove can be used on win7/8/10.
4. Currently both VIVE tracker and controller are supported as optical tracking devices for Hi5 and mounted on Hi5 gloves.
5. You are suggested NOT to hold VIVE controller or any other magnetic or ferrous objects in hand when wearing Hi5 glove, since it will influence the motion capture performance.

Basic using steps (for reference):

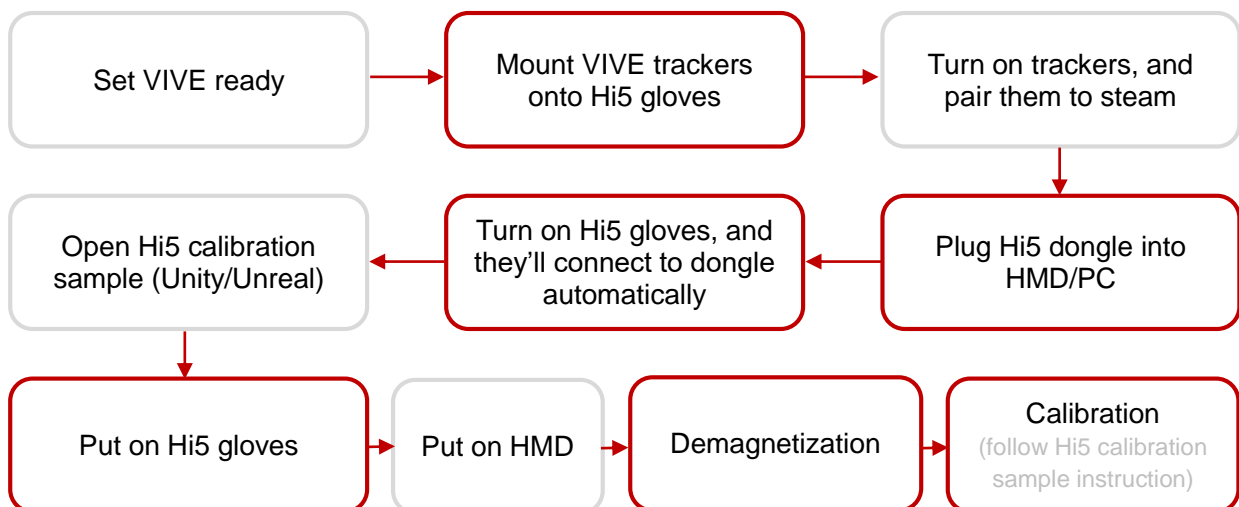

NOITOM®	Hi5 VR Glove	Developer Guidelines
	NOITOM corporation	Dec.2017 V1.2

2. Hardware Parts

2.1 Components

Noitom Hi5 comes packaged with 1 pair of Hi5 Gloves (“Glove”) and 1 USB 2.0 transceiver (“Dongle”):

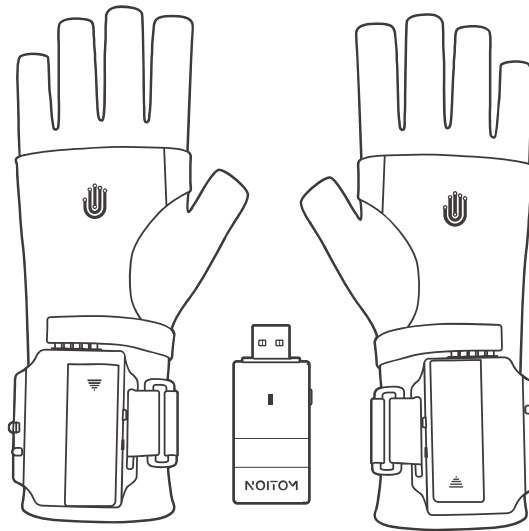

(Figure 2.1-1)

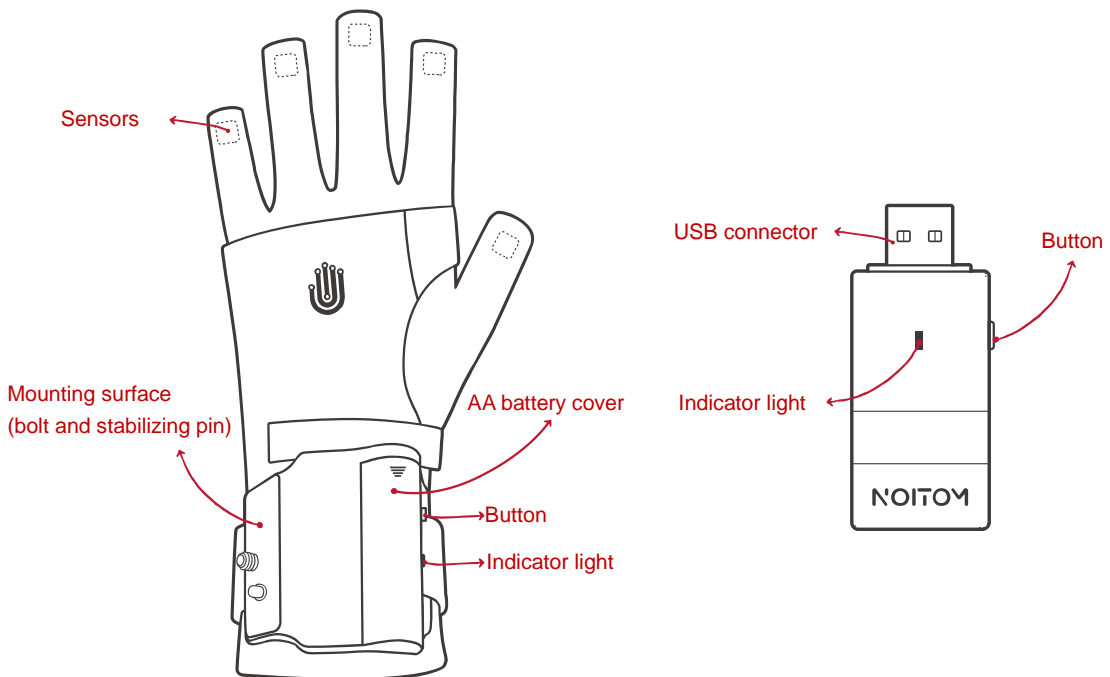

(Figure 2.1-2)

NOITOM®	Hi5 VR Glove	Developer Guidelines
	NOITOM corporation	Dec.2017 V1.2

2.2 Interaction Interfaces

There is one button and one indicator light for each Glove and each Dongle. The interaction lookup table is as follows:

Button Functions:

Function	Operation and Indication	On Glove/Dongle
Turning on the Glove	Press the button when the Glove is powered off (click)	Glove
Turning off the Glove	Press and hold the button for 5 seconds (release after the indicator light turns off)	Glove
Entering pairing mode	Press and hold the buttons for 3 seconds (release when the indicator lights turn on to a solid state)	Glove & Dongle
Manually switching working frequency	Short press the button (click)	Dongle
Restarting Glove	Short press the button when the Glove is in working mode (click)	Glove

(Table 2.2-1)

Indicator Light States:

Meaning	Indicator Light State	On Glove/Dongle
Powered off	Turned off	Glove
Standby	Breathing	Glove & Dongle
Pairing mode	1Hz flashing (slowly flashing)	Glove & Dongle
Working mode	20Hz flashing (rapid flashing)	Glove & Dongle
The current ambient environment has magnetic interference	Solid state turned on (in working mode)	Glove
Error 01 (Self-test error)	Solid state turned on (right after power on)	Glove & Dongle
Error 02 (enter Boot mode)	3s off, 0.1s on	Glove & Dongle

(Table 2.2-2)

Notice: The indicator light on the Gloves will turn RED when the battery power is low.

NOITOM®	Hi5 VR Glove	Developer Guidelines
	NOITOM corporation	Dec.2017 V1.2

Vibration States:

Meaning	States	On Glove/Dongle
Glove power on	Vibrate for 0.5s	Glove

(Table 2.2-2)

2.3 Features

- 9-DOF IMU for 5 fingers and the back of hand
- Vibration feedback for each Glove
- Supply voltage range of 1.0-1.5VDC with one AA battery for each Glove
- Supply voltage range of 5 ± 0.25 VDC for Dongle
- 7 hours of working time with 2100mAh Alkaline battery
- Latency less than 5 ms (From motion to SDK, under clean RF condition)
- Output data rate up to 180Hz
- RF working area: 5m×5m (open area without interference)
- automatic channel-switching to avoid RF interference

2.4 Radio Frequency (RF)

1. Working frequency: 2.4GHz
2. Restricted Area of Antenna

The figure below illustrates the “keep out” area where only nonmetallic parts of the accessory should be inside (spherical radius=20mm and the center is antenna feed point).

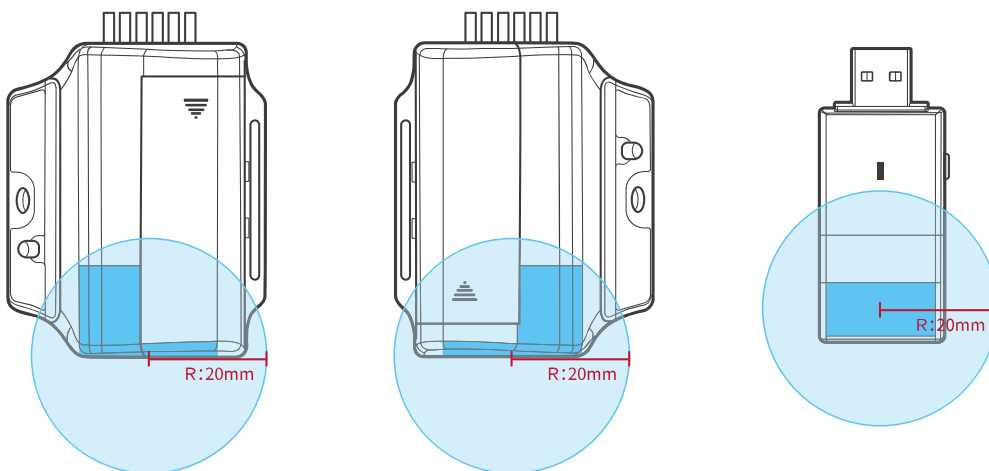

(Figure 2.4-1: Restricted Area of Antenna)

NOITOM [®]	Hi5 VR Glove	Developer Guidelines
	NOITOM corporation	Sep.2017 V1.1

- Support up to 6 sets of Hi5 working in the same field simultaneously (in different working frequency; clean RF environment required).

Notice:

- Making the antenna side of Dongle points to the Gloves can get better RF performance (keep the Dongle at the same height as the Glove);
- Setting the wireless card of laptop to flight mode can get better RF performance;
- You can switch the working frequency manually (click the button of Dongle) when the RF performance is bad (lagging hands in HMD).

2.5 Usages

2.5.1 Basic Operation Steps

Step 1: Preparing

- Install AA Batteries into Gloves.
- Mount optical tracking devices to Gloves (see “3.1 Mounting Optical Tracking Devices”).

Step 2: Plugging in the Dongle

Plug the Dongle into PC. The indicator light of Dongle will start to breathe.

If possible, please plug the Dongle directly into the USB port on the VIVE headset using a USB extender (not provided) to get the best RF performance with the Hi5 Gloves.

Step 3: Starting the Gloves

Turn on the Gloves (press the button on the Gloves), and the indicator light will start to breathe.

Then normally the Gloves should connect to Dongle automatically, and the indicator light of both Gloves and Dongle will turn to rapid flashing immediately (then skip Step 4). However, if the indicator light keeps breathe, please do Step 4.

Reminder: If you use optical tracking devices (such as VIVE Tracker) on Hi5, please do not forget to start them to get the positions of your hands.

Step 4 (Optional): Pairing Gloves with Dongle

(see “2.5.2 Pairing Gloves”)

Step 5: Wearing Gloves

- (Suggested) Wearing inner plastic gloves before putting on the Hi5 Gloves
- Wearing Hi5 Gloves (see “3.2 Wearing Gloves”)

NOITOM®	Hi5 VR Glove	Developer Guidelines
	NOITOM corporation	Sep.2017 V1.1

Step 6: Demagnetization (see “2.5.3 Demagnetization”)

Step 7: Calibration (see “5. Calibration Instructions”)

2.5.2 Pairing Gloves

Each set of Hi5 **HAS ALREADY BEEN PAIRED** in the factory, so normally you **DO NOT** need to pair them again and the Glove will connect to the Dongle automatically. However, if you mix different sets of Gloves up (the indicator lights of the Gloves and Dongle remain in breathing status), you need to re-pair the Dongle and Gloves. The method is as follows:

Step 1. Dongle:

1. Plug in the Dongle into PC:

The indicator light will start to breathe.

2. The Dongle entering pairing mode:

Press and hold the button on the Dongle for 3 seconds (release when the indicator light turns on to a solid state): The indicator light will slowly flash (flash at 1Hz). Now the Dongle is in pairing mode and waiting for connection with the Glove/Gloves.

Step 2. Glove:

A. Pair of Gloves:

1. Turn on both Gloves:

The indicator lights on both Gloves will start to breathe.

2. Both Gloves entering the pairing mode:

Pressing and holding the buttons of both Gloves for 3 seconds (release when the 2 indicator lights turn on to a solid state) : The 2 indicator lights will slowly flash (flash at 1Hz). Now the Gloves are in pairing mode and they will connect to the Dongle automatically.

3. Now the Gloves and Dongle will enter working mode automatically (rapid flashing at 20Hz). The pairing operation for one pair of Gloves is now completed.

B. Single Glove:

1. Turn on the Glove:

NOITOM®	Hi5 VR Glove	Developer Guidelines
	NOITOM corporation	Sep.2017 V1.1

The indicator light will start to breathe.

2. The Glove entering pairing mode:

Press and hold the button on the Glove for 3 seconds (release when the indicator light turns on to a solid state): The indicator light will slowly flash (flash at 1Hz). Now the Glove is in pairing mode and it will connect to the Dongle automatically (the indicator light will breathe after pairing).

3. Re-plug the Dongle into PC.

4. Now the Glove and Dongle will enter working mode automatically (rapid flashing at 20Hz). The pairing operation for single Glove is now completed.

Notice:

- Please make sure the battery is full when pairing Gloves.
- If you have more than one set of Hi5 Gloves that need to be paired, please do the above operation one set at a time, but not at the same time.
- You can stick the same color stickers on each set of already paired Gloves and Dongle, to avoid mixing up different pairs of Gloves.
- Once paired, the Glove and Dongle will reconnect automatically in the future.
- You can also refer to the [“Pairing Glove Tutorial Video”](#) on the Hi5 website [“hi5vrglove.com”](http://hi5vrglove.com) to get a more comprehensive understanding of how to do the pairing glove procedure.

2.5.3 Demagnetization

[IMPORTANT] Demagnetization is the fundamental operation of Hi5. Please make sure you finish demagnetization procedure successfully before you do other operations.

If you find obvious drifting of the hands model during use, or the Dongle indicator light flashes and the Glove indicator light turns on to a solid state, or you see the “magnet icon” in Hi5 calibration sample turns red, this means that there is magnetic interference around the sensors (or the sensors are magnetized).

1. First, please check if the magnetic environment is clean and if there are any ferromagnetic substances around the Gloves. If so, please keep the gloves away from all the above environment or substances (Including but not limited to the following items).

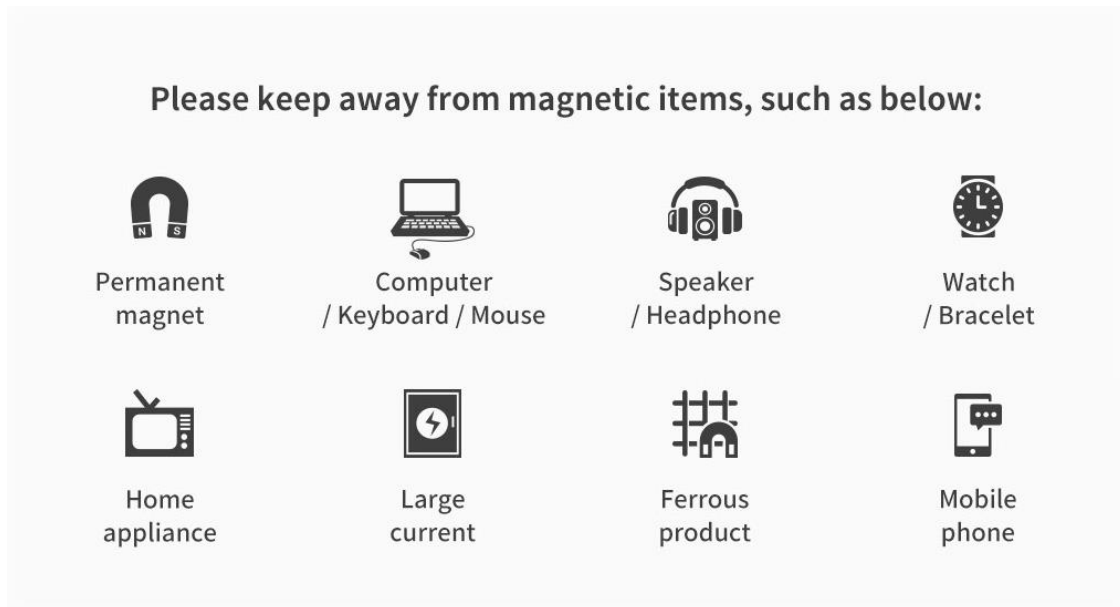

(Figure 2.5-1: keep away from magnetic items)

2. Do demagnetization operation: please refer to the **“Demagnetization Tutorial Video”** on the Hi5 website **“hi5vrglove.com”** to get a more comprehensive understanding of how to do the demagnetization procedure.
3. The drifting problem will disappear and the Gloves indicator light will return to rapid flashing after you finish the demagnetization operation successfully.

NOITOM®	Hi5 VR Glove	Developer Guidelines
	NOITOM corporation	Sep.2017 V1.1

3. Mechanical Parts

3.1 Mounting Optical Tracking Devices

Mounting optical tracking devices directly onto Hi5 Gloves

Example: Mounting VIVE Tracker (“Tracker”)

Step 1. Find the 1/4” bolt and the stabilizing pin on the Glove.

Find the 1/4” screw nut and the stabilizing pin recess on the back of the Tracker.

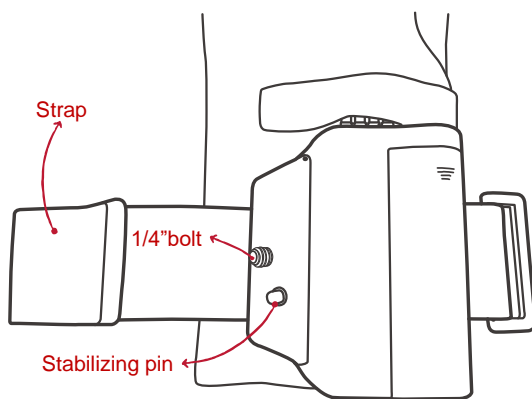

(Figure 3.1-1 Hi5 Glove)

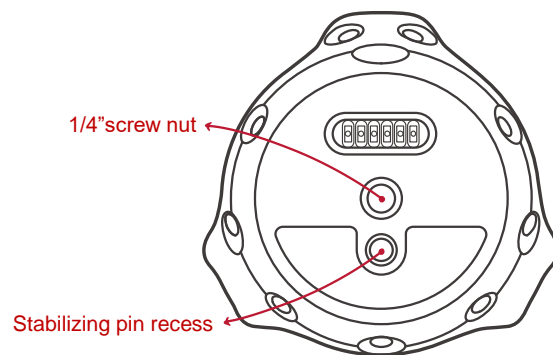

(Figure 3.1-2 VIVE Tracker)

Step 2. Loosen the strap (no need to take the strap off, you will need to open the velcro on the bottom), and you will find the bolt ring on the back side of the Glove’s plastic casing.

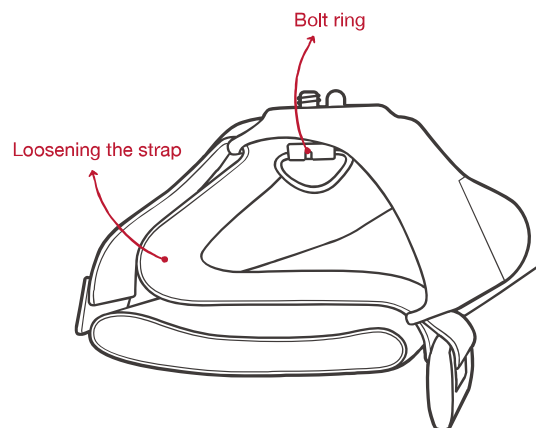

(Figure 3.1-3)

NOITOM®	Hi5 VR Glove	Developer Guidelines
	NOITOM corporation	Sep.2017 V1.1

Step 3. Align the stabilizing pin (Glove) to the stabilizing pin recess (Tracker) and the bolt (Glove) to the screw nut (Tracker), and screw tightly. Please do NOT pull downward on the bolt when screwing in the Tracker.

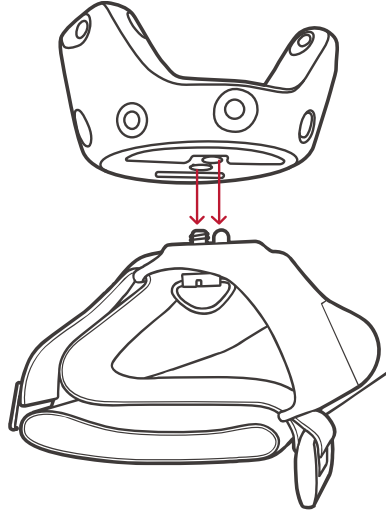

(Figure 3.1-4)

Step 4. Tighten up the strap and close the underneath velcro. Mounting completed. Please reverse the steps when taking the Tracker off from the Hi5 Glove.

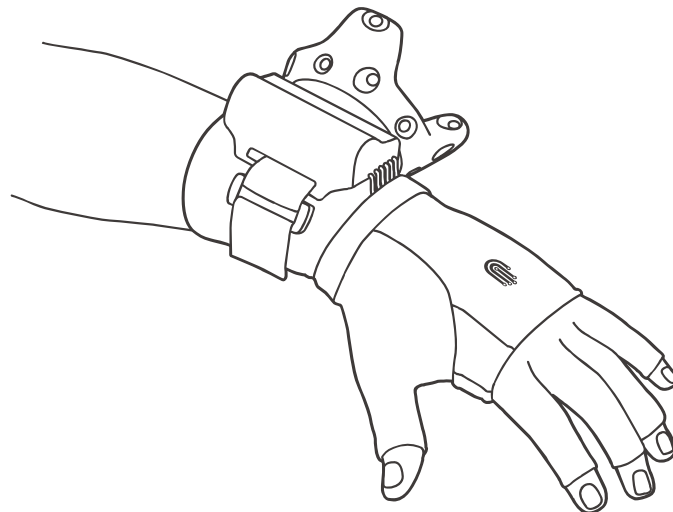

(Figure 3.1-5)

It's also supported to use VIVE controller ("Controller") as the optical tracking device instead of Tracker. Please use the "Hi5-VIVE Controller Connector" ("Connector", sold separately) to mount the controller onto Hi5 Glove. The way of mounting Connector is the same as mounting Tracker; and it's suggested to mount the Connector to Hi5 first, then put on Hi5, then put the Controller into the Connector after wearing Hi5, since the Controller is heavy.

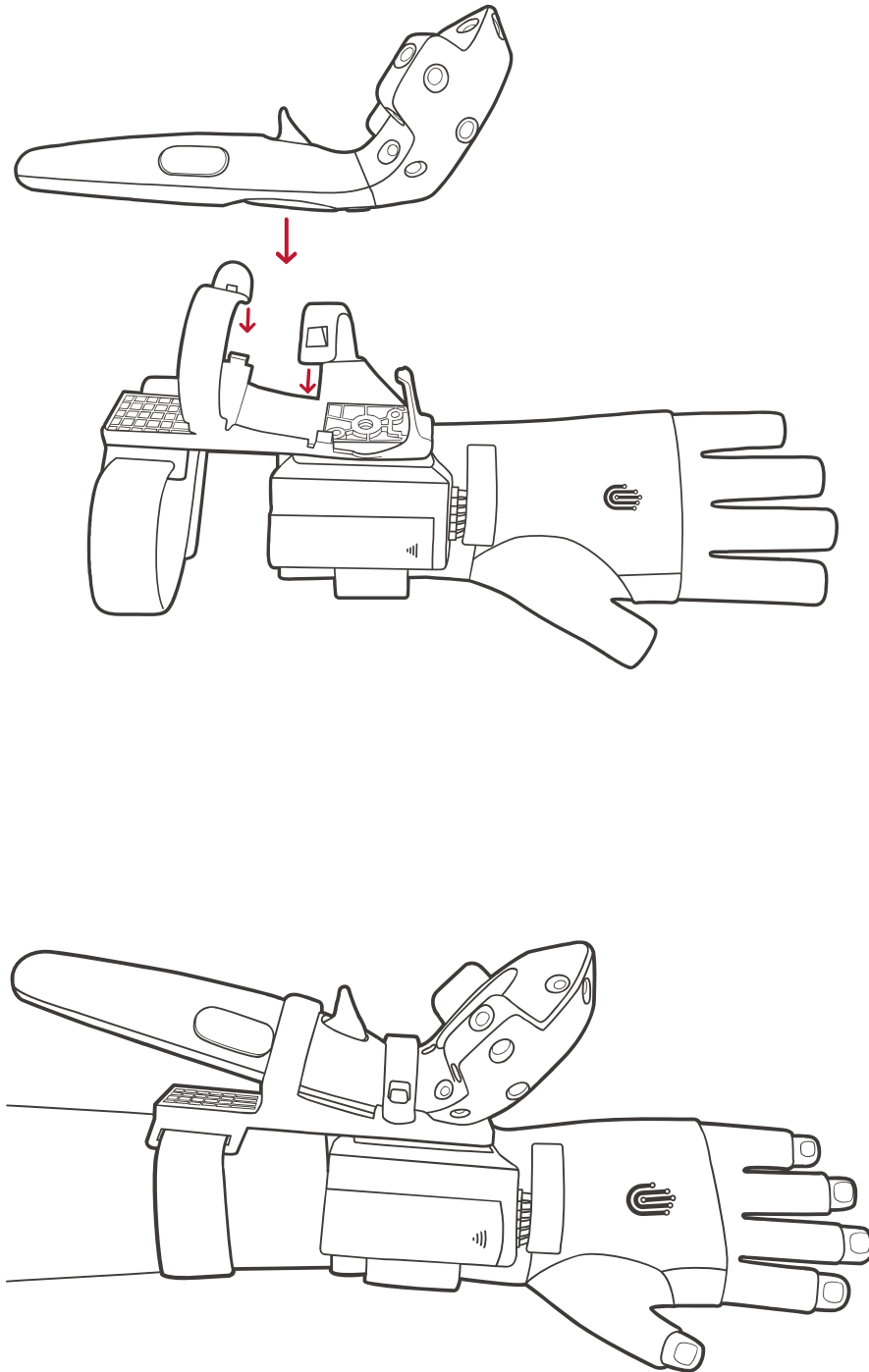

(Figure 3.1-6)

NOITOM®	Hi5 VR Glove	Developer Guidelines
	NOITOM corporation	Sep.2017 V1.1

3.2 Wearing Gloves

Steps and things to note when putting on and taking off the Gloves:

1. Take off watches and bracelets and roll up your sleeves before wearing the Hi5 Gloves.
2. Mount the optical tracking device successfully BEFORE wearing the Hi5 Gloves.
3. It's recommended to wear thin plastic gloves before putting on the Hi5 Gloves (you can find 2 pairs of plastic gloves in every Hi5 package).
4. Open the velcro on the wrist strap and put on the Hi5 Glove to the right position, then tighten and fasten the strap.

Notice:

- When adjusting the wrist strap, pull the PU pad on the end of the strap instead of tugging on the velcro directly, to avoid damaging the fabric.
- Each finger sensor should be right on the top of THE 2nd SECTION of each finger.

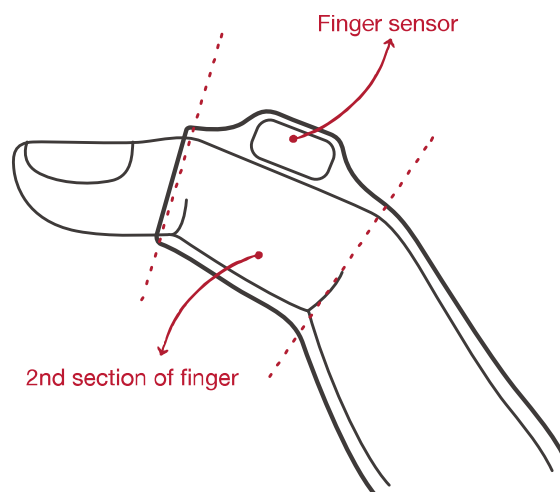

(Figure 3.2-1)

- The relative positions of sensors and the optical tracking device to the hand should NOT change due to hand movements.

NOITOM®	Hi5 VR Glove	Developer Guidelines
	NOITOM corporation	Sep.2017 V1.1

5. Taking off Hi5 Gloves:

Notice: To avoid damaging the Gloves, please DO NOT pull on the inner cables when taking off the Gloves.

Step 1. Loosen the wrist strap first.

Step 2. Pull the Gloves fingertips a little past your fingertips.

Step 3. Take off the Gloves by pulling the 2 strap rings on the palm side (beneath the cover fabric), in order to avoid pulling inner cables.

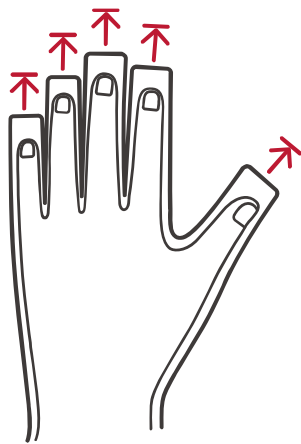

(Figure 3.2-2)

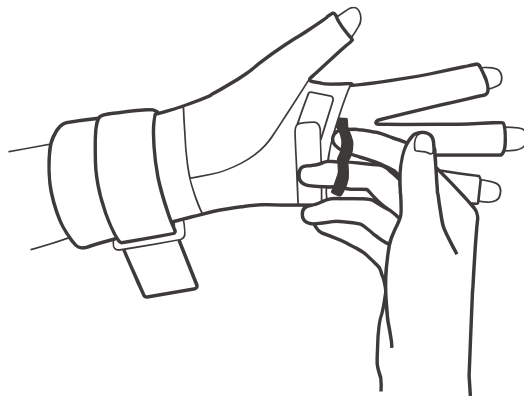

(Figure 3.2-3)

NOITOM®	Hi5 VR Glove	Developer Guidelines
	NOITOM corporation	Sep.2017 V1.1

4. SDK

Unity and Unreal SDKs, calibration samples and relevant documents for Hi5 are provided on the Hi5 website "hi5vrglove.com". Please download them there.

NOITOM®	Hi5 VR Glove	Developer Guidelines
	NOITOM corporation	Sep.2017 V1.1

5. Calibration Instructions

5.1 Notice

1. Before doing this calibration, please make sure your Hi5 Gloves are not magnetized. To demagnetize the Hi5 Gloves, please follow the demagnetization instructions.
2. Please do the calibration procedure every time the optical tracking system is either moved, recalibrated, or when the user of the Hi5 Gloves is changed.
3. When doing the calibration, make sure the optical tracking devices don't lose tracking during the whole calibration process, otherwise the calibration results will be wrong.
4. Please watch the "Calibration Tutorial Video" on the Hi5 website "hi5vrglove.com" to get a more comprehensive understanding of how to do the calibration poses.

5.2 Calibration Steps

The full calibration procedure includes two steps in order: B pose (Buddha pose) and P pose (Pinch pose). The B pose is the basic pose, which MUST be done after you set up your optical tracking system. P pose will improve your thumb performance to achieve "finger touch". However, if you are already satisfied with B pose results, P pose is optional.

Step 1. B (Buddha) pose:

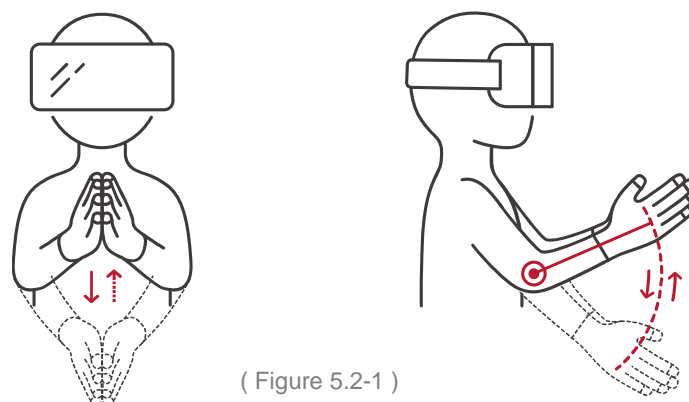

(Figure 5.2-1)

B pose is used to calibrate the rotation between the optical tracking system and the Glove's inertial global coordinate system, and your palm and finger (except thumb) sensors. It is a dynamic calibration pose.

NOITOM®	Hi5 VR Glove	Developer Guidelines
	NOITOM corporation	Sep.2017 V1.1

When you use the system for the first time, or any time you move or recalibrate the optical tracking system, you **MUST** do B pose calibration to get the correct relation between the optical and inertial systems.

1. Keep the palms of your hands touching together in front of your chest.
2. All fingers, except thumbs, should be kept close together and point the same direction in front of your body.
3. Keep your hands and forearms on a straight line.
4. Start with your forearms pointing the oblique up direction, and rotate your forearms around elbow joints between upper to lower positions 2~3 times.

Pay Attention:

Avoid fingers pointing vertically upward, pointing the rear direction of your body, pointing to the left or right of your facing direction, or askew moving route.

The following are some typical **WRONG** B poses:

- The fingers are pointing to the left or right of your facing direction.

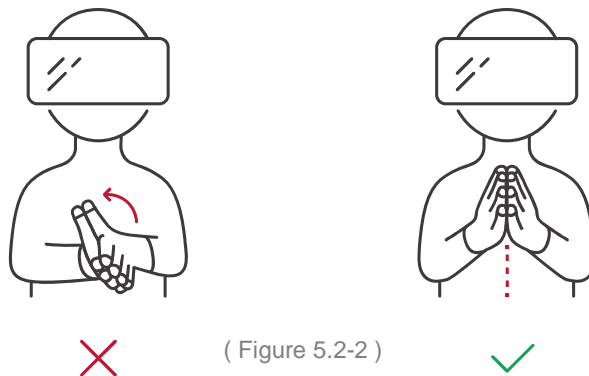

- The palms are not perpendicular to the ground.

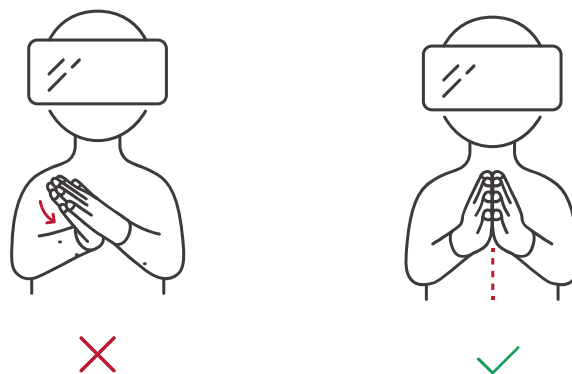

- The fingers are splayed or the fingers and forearm are not pointing to the same direction on a straight line.

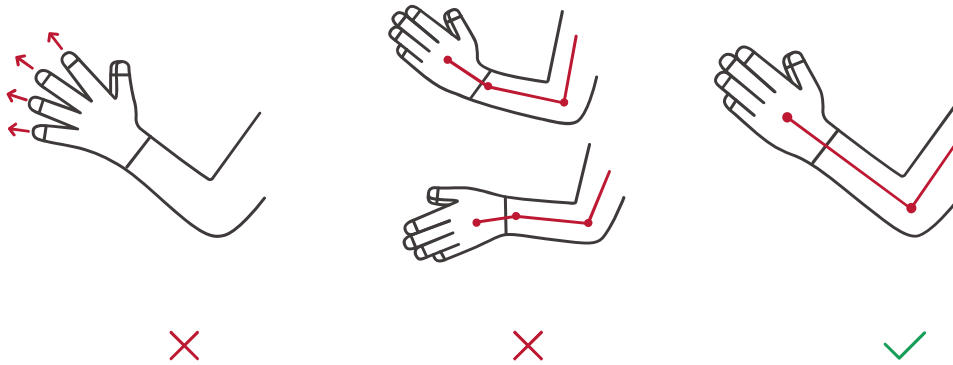

(Figure 5.2-4)

- The fingers are pointing vertically upward or pointing the rear direction of your body.

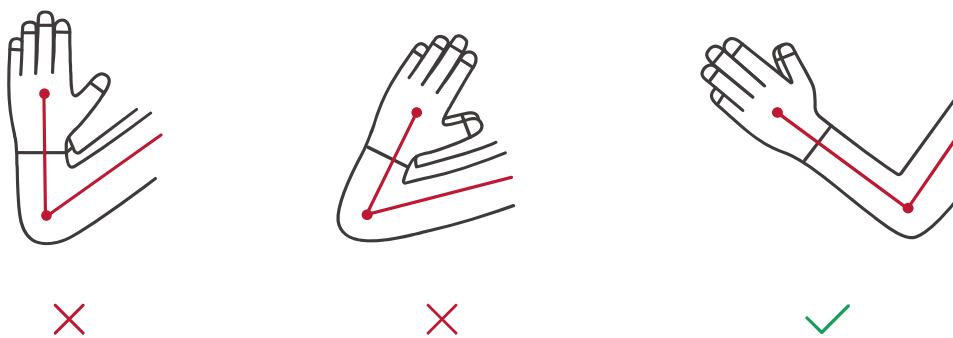

(Figure 5.2-5)

- The moving route is askew.

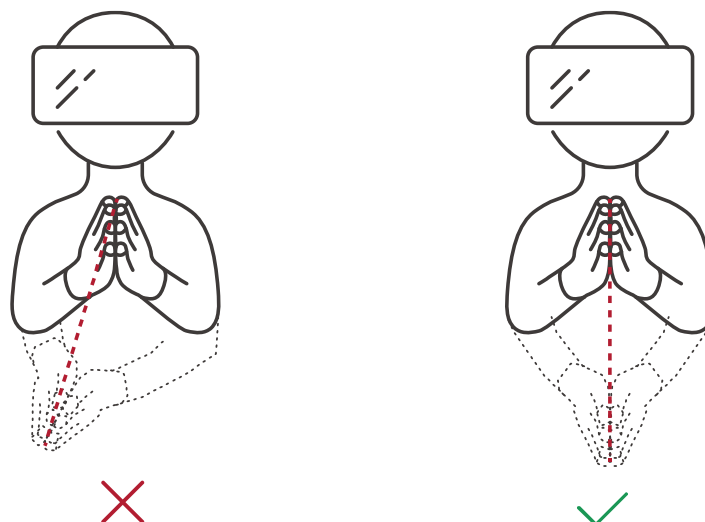

(Figure 5.2-6)

Step 3. P (Pinch) pose:

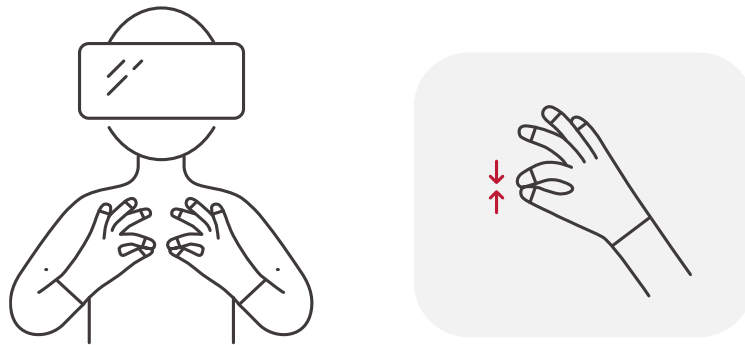

(Figure 5.2-7)

P pose is used to calibrate your thumb sensors. It is a static calibration pose.

- On both hands, touch the thumb and index finger lightly together. Keep thumb **STRAIGHT** from thumb root to thumb tip.
- The index finger should bend naturally and touch the tip of the thumb.
- The other three fingers should be kept in a resting position (no posture requirements).

Pay Attention:

- Avoid obvious joint bending between thumb tip and the 2nd bone.

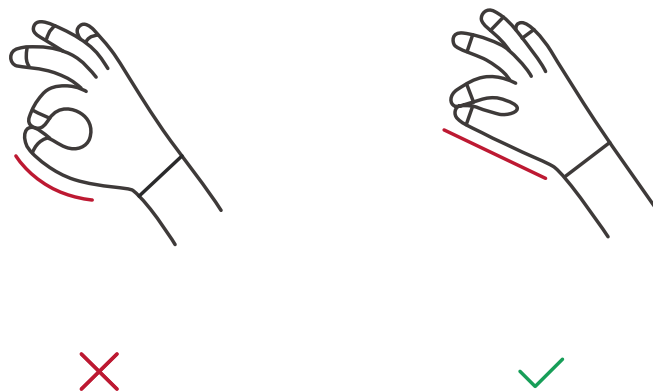

(Figure 5.2-8)

NOITOM®	Hi5 VR Glove	Developer Guidelines
	NOITOM corporation	Sep.2017 V1.1

FCC Statement:

This device complies with part 15 of the FCC Rules. Operation is subject to the following two conditions:

- (1) This device may not cause harmful interference, and*
- (2) this device must accept any interference received, including interference that may cause undesired operation.*

NOTE: This equipment has been tested and found to comply with the limits for a Class B digital device, pursuant to part 15 of the FCC Rules. These limits are designed to provide reasonable protection against harmful interference in a residential installation.

This equipment generates, uses and can radiate radio frequency energy and, if not installed and used in accordance with the instructions, may cause harmful interference to radio communications. However, there is no guarantee that interference will not occur in a particular installation.

If this equipment does cause harmful interference to radio or television reception, which can be determined by turning the equipment off and on, the user is encouraged to try to correct the interference by one or more of the following measures:

- Reorient or relocate the receiving antenna.*
- Increase the separation between the equipment and receiver.*
- Connect the equipment into an outlet on a circuit different from that to which the receiver is connected.*
- Consult the dealer or an experienced radio/TV technician for help.*

Changes or modifications not expressly approved by the party responsible for compliance could void the user's authority to operate the equipment.